

SPEC No.	DG-096014
----------	-----------

ISSUE: _____

To: _____

S P E C I F I C A T I O N S

Product Type LIGHT EMITTING DIODE MODULE

Model No. **GW5BTC15L02**

※These specifications contain 14 pages including the cover and appendix.
If you have any objections, please contact us before issuing purchasing order.

CUSTOMERS ACCEPTANCE

DATE: _____

BY: _____

PRESENTED

BY: _____

M.Katoh
Dept. General Manager

REVIEWED BY:

PREPARED BY:

Development Department II
System Device Division III
Electronic Components And Devices Group
SHARP CORPORATION

- Handle this document carefully for it contains material protected by international copyright law. Any reproduction, full or in part, of this material is prohibited without the express written permission of the company.

- When using the products covered herein, please observe the conditions written herein and the precautions outlined in the following paragraphs. In no event shall the company be liable for any damages resulting from failure to strictly adhere to these conditions and precautions.

(1) The products covered herein are designed and manufactured for the following application areas. When using the products covered herein for the equipment listed in paragraph (2), even for the following application areas, be sure to observe the precautions given in Paragraph (2). Never use the products for the equipment listed in Paragraph (3).

- Office electronics
- Instrumentation and measuring equipment
- Machine tools
- Audiovisual equipment
- Home appliances
- Communication equipment other than for trunk lines

(2) These contemplating using the products covered herein for the following equipment which demands high reliability, should first contact a sales representative of the company and then accept responsibility for incorporating into the design fail-safe operation, redundancy, and other appropriate measures for ensuring reliability and safety of the equipment and the overall system.

- Control and safety devices for airplanes, trains, automobiles, and other transportation equipment
- Mainframe computers
- traffic control systems
- Gas leak detectors and automatic cutoff devices
- Rescue and security equipment
- Other safety devices and safety equipment, etc.

(3) Do not use the products covered herein for the following equipment which demands extremely high performance in terms of functionality, reliability, or accuracy

- Aerospace equipment
- Communications equipment for trunk lines
- Control equipment for the nuclear power industry
- Medical equipment related to life support, etc.

(4) please direct all queries and comments regarding the interpretation of the above three Paragraphs to a sales representative of the company.

- Please direct all queries regarding the products covered herein to a sales representative of the company.

GW5BTC15L02 specifications

1. Application

These specifications apply to the light emitting diode module Model No. GW5BTC15L02.

["High color rendering" Warm White (from InGaN Blue LED chip + Phosphor) LED module]

Main application : Illumination

2. External dimensions and equivalent circuit ----- Refer to Page 2.

3. Ratings and characteristics ----- Refer to Page 3 - 5.

3-1. Absolute maximum ratings

3-2. Electro-optical characteristics

3-3. Derating curve

3-4. Characteristics diagram (TYP.)

4. Reliability ----- Refer to Page 6.

4-1. Test items and test conditions

4-2. Failure criteria

5. Quality label ----- Refer to Page 7.

5-1. Applied standard

5-2. Sampling inspection

5-3. Inspection items and defect criteria

6. Supplements----- Refer to Page 8 - 9.

6-1. Chromaticity rank table

6-2. Packing

6-3. Label

6-4. Indication printed on product

7. Precautions ----- Refer to Page 10 - 12.

Model No.	Page
GW5BTC15L02	2/12

2. External dimensions and equivalent circuit

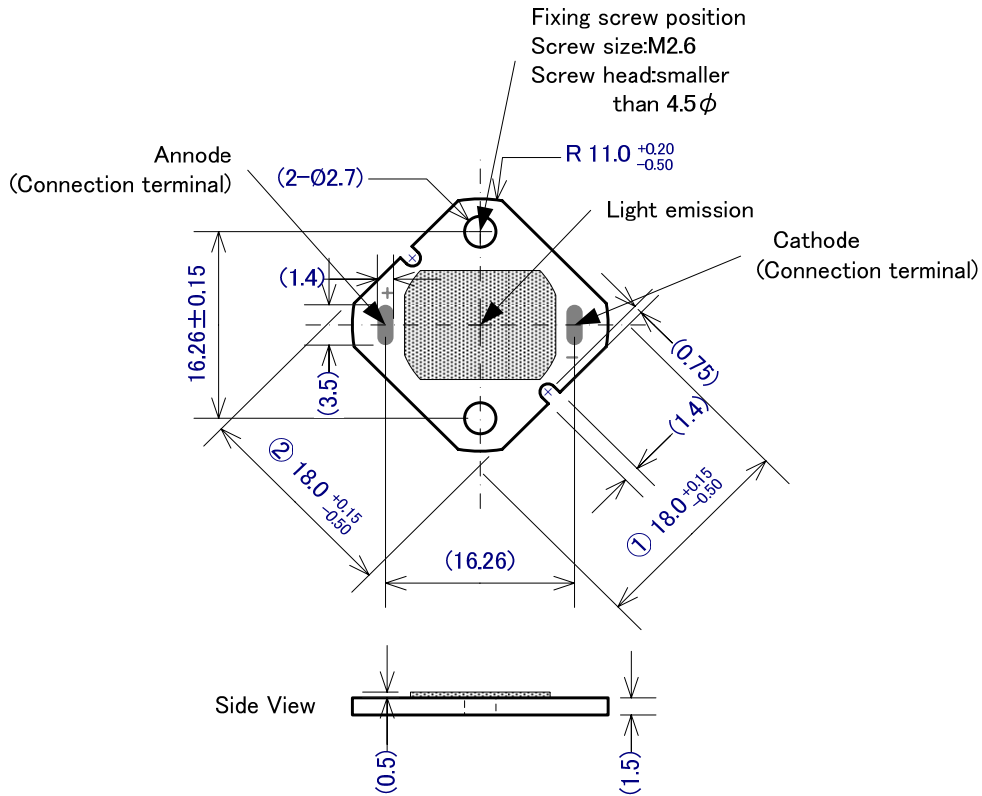

(Note) Values inside parentheses are reference values.

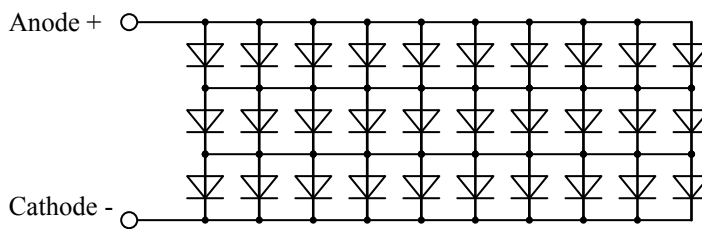

Equivalent circuit

(Note) 3 series × 10 parallel = 30 pcs of LEDs
 (3 serially connected LEDs compose a block. 10 blocks are parallel connected)

Unit	Material	Finish	Drawing No.
mm	Substrate: Alumina ceramic	Connection terminal: Au plating	52010029

3. Ratings and characteristics

3-1. Absolute maximum ratings

Item	Symbol	Rating	Unit
Power Dissipation *1,4	P	4.4	W
Forward Current *1,4	I _F	400	mA
Reverse Voltage *2,4	V _R	-15	V
Operating Temperature *3	T _{opr}	- 30 ~ + 90	°C
Storage Temperature	T _{stg}	- 40 ~ + 100	°C

*1 Power dissipation and forward current are the value when the module temperature is set lower than the rating by using an adequate heat sink.

*2 Voltage resistible at initial connection error

(Not dealing with the possibility of always-on reverse voltage.)

*3 Case temperature T_c (Refer to measuring point for case temperature in the next page.)

Refer to "Derating curve" in the next page as for operating current.

*4 T_c = 25 °C

3-2. Electro-optical characteristics

(T_c = 25 °C)

Item	Symbol	Condition	MIN.	TYP.	MAX.	Unit
Forward Voltage	V _F	I _F = 360 mA	8.5	(10.2)	11.5	V
Luminous Flux *5	Φ	I _F = 360 mA	135	(190)	-	lm
Chromaticity Coordinates *6	x	I _F = 360 mA	-	0.434	-	-
	y		-	0.403	-	-
Color Temperature	-	I _F = 360 mA	(2870)	3045	(3220)	K
CRI *7	R _a	I _F = 360 mA	-	(85)	-	-

(Note) Values inside parentheses are shown for reference purpose only.

*5 Monitored by Sharp's 8 inch integrating sphere and Otsuka electronics MCPD-LE3400
(After 20 ms drive, Measuring error: ± 20 %)

*6 Monitored by Sharp's 8 inch integrating sphere and Otsuka electronics MCPD-LE3400
(After 20 ms drive, Measuring error: x,y ± 0.02)

*7 Monitored by Sharp's 8 inch integrating sphere and Otsuka electronics MCPD-LE3400
(After 20 ms drive, Measuring error: ± 4%)

3-3. Derating curve

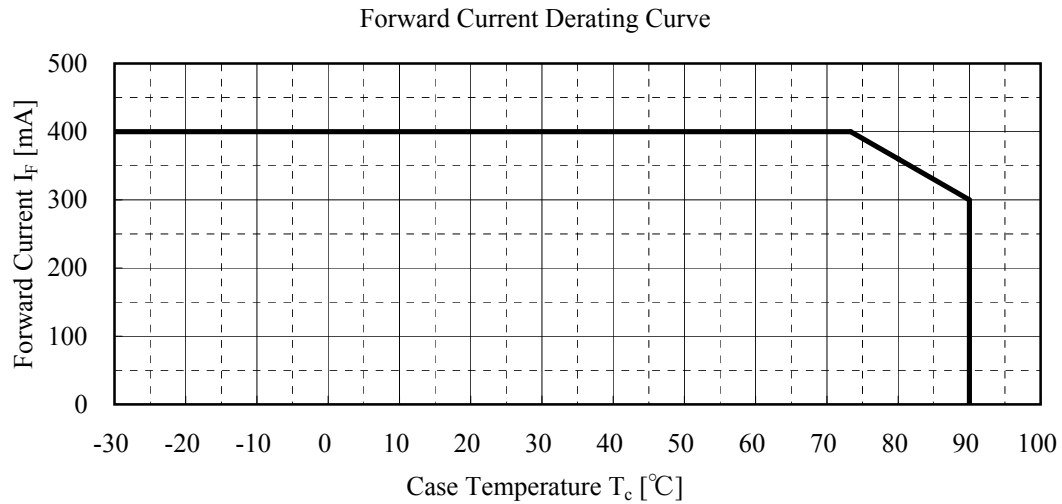

(Note) To keep the case temperature lower than the rating, enough heat-radiation performance needs to be secured by using an adequate heat sink.

To secure long-term life, use it by the current equal to or less than 360 mA.

(Measuring point for case temperature)

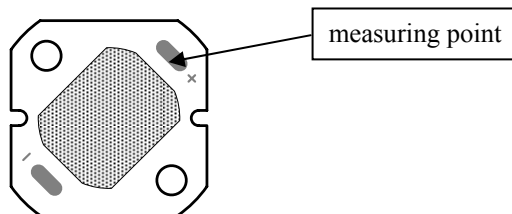

(Example of heat sink attachment)

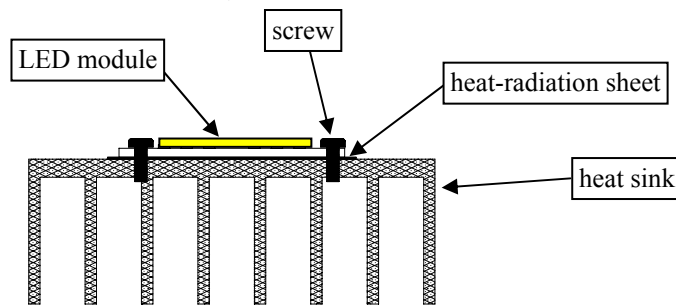

(Thermal resistance)

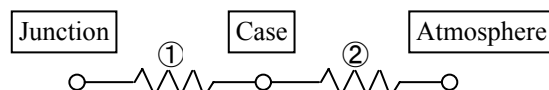

① Thermal resistance: $6.5^{\circ}\text{C}/\text{W}$ < Reference value >

(Junction-Case)

② Thermal resistance : Depends on a performance of attached heat sink.

(Case-Atmosphere)

3-4. Characteristics diagram (TYP.)

Forward Current vs. Relative Luminous Flux

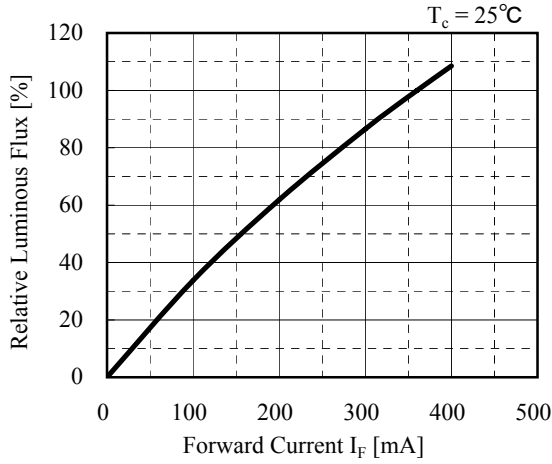

Forward Voltage vs. Forward Current

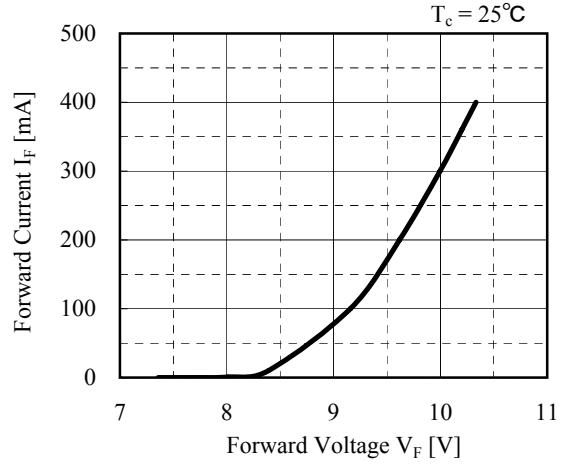

Case Temperature vs. Relative Luminous Flux

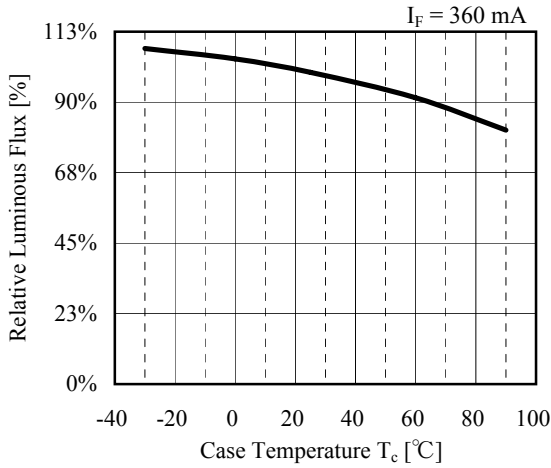

Case Temperature vs. Forward Voltage

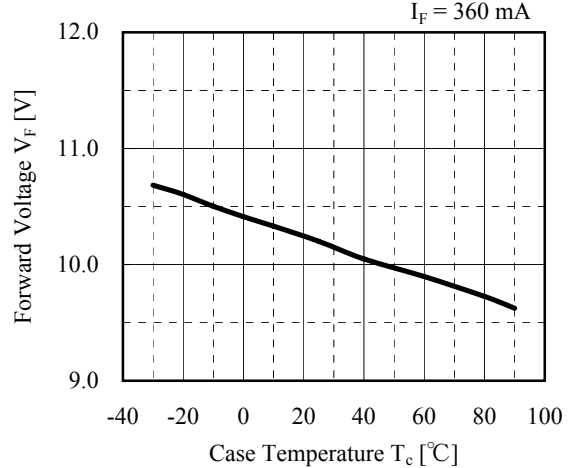

Chromaticity Coordinate vs. Case Temperature

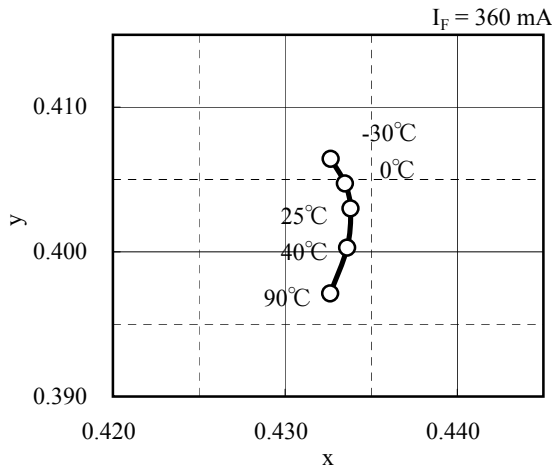

Case temperature vs Color temperature

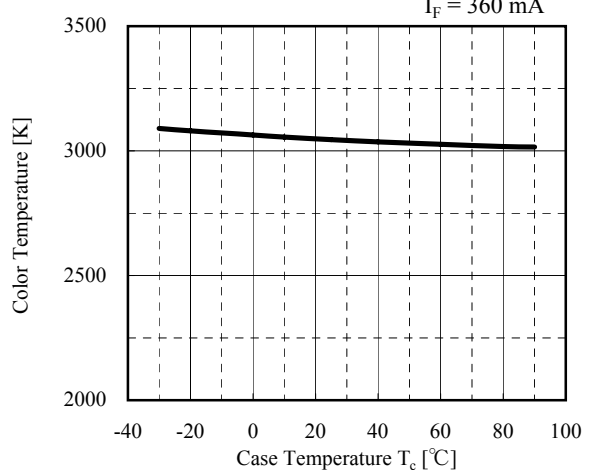

(Note) Characteristics data shown here are for reference purpose only. (Not guaranteed data)

4. Reliability

The reliability of products shall be satisfied with items listed below.

4-1. Test items and test conditions

Confidence level: 90 %

No.	Test item	Test conditions	Samples n	Defective C	LTPD (%)
1	Temperature Cycle	- 40 °C(30 min) ~ + 100 °C(30 min), 30 cycles	11	0	20
2	Temperature Humidity Storage	T _{stg} = + 60 °C, RH = 90 %, Time = 1000 h	11	0	20
3	High Temperature Storage	T _{stg} = + 100°C, Time = 1000 h	11	0	20
4	Low Temperature Storage	T _{stg} = - 40 °C, Time = 1000 h	11	0	20
5	Steady State Operating Life	T _c = 60 °C, I _F = 400 mA, Time = 1000 h	11	0	20
6	Shock	Acceleration: 15000 m/s ² , Pulse width: 0.5 ms Direction: 3 directions (X, Y and Z) 3 trials in each direction	5	0	50
7	Vibration	Frequency: 100 to 2000 Hz for 4 minutes per trial Acceleration: 200 m/s ² Direction: 3 directions (X, Y and Z) 4 trials in each direction	5	0	50

4-2. Failure criter

No.	Parameter	Symbol	Failure criteria
1	Forward Voltage	V _F	V _F > U.S.L × 1.2
2	Luminous Flux	Φ	Φ < Initial value × 0.5, Φ > Initial value × 2.0

(Note) U.S.L. stands for Upper Specification Limit.

Model No.	Page
GW5BTC15L02	7/12

5. Quality level

5-1. Applied standard

ISO2859-1

5-2. Sampling inspection

A single normal sampling plan, level S-4.

5-3. Inspection items and defect criteria

No.	Item	Defect criteria	Classification	AQL
1	No radiation	No light emitting	Major defect	0.1%
2	Electro-optical characteristics	Not conforming to the specification (Forward voltage, Luminous flux and Chromaticity)	Minor defect	0.4%
3	External dimensions	Not conforming to the specified dimensions (External dimensions of ① and ② shown in Page 3)		
4	Appearance	Nonconformity observed in product appearance is determined as defective only when electro-optical characteristics is affected by. <If any question arises regardless of above mentioned criterion> <ul style="list-style-type: none"> ■ Foreign material, scratch, or bubble at emitting area: 0.8 mmφ ■ Fiber generation at emitting area: 0.2 mm in width and 2.5 mm in length ■ Foreign material at connection terminal: 0.8 mmφ ■ Substrate burr on edge: Over dimension tolerance ■ Resin chipping: 0.8 mmφ 		

(Note) Products with removable foreign material attached on is not determined to be defective.

Warm White (3000 K)						($I_F = 360 \text{ mA}$, $T_c = 25 \text{ }^\circ\text{C}$)
Rank		Chromaticity Diagram				CCT (K)
		Point 1	Point 2	Point 3	Point 4	
1	x	0.430	0.415	0.437	0.456	2870 ~ 3220
	y	0.417	0.381	0.389	0.426	

(Tolerance $x,y = \pm 0.02$)

Chromaticity Diagram

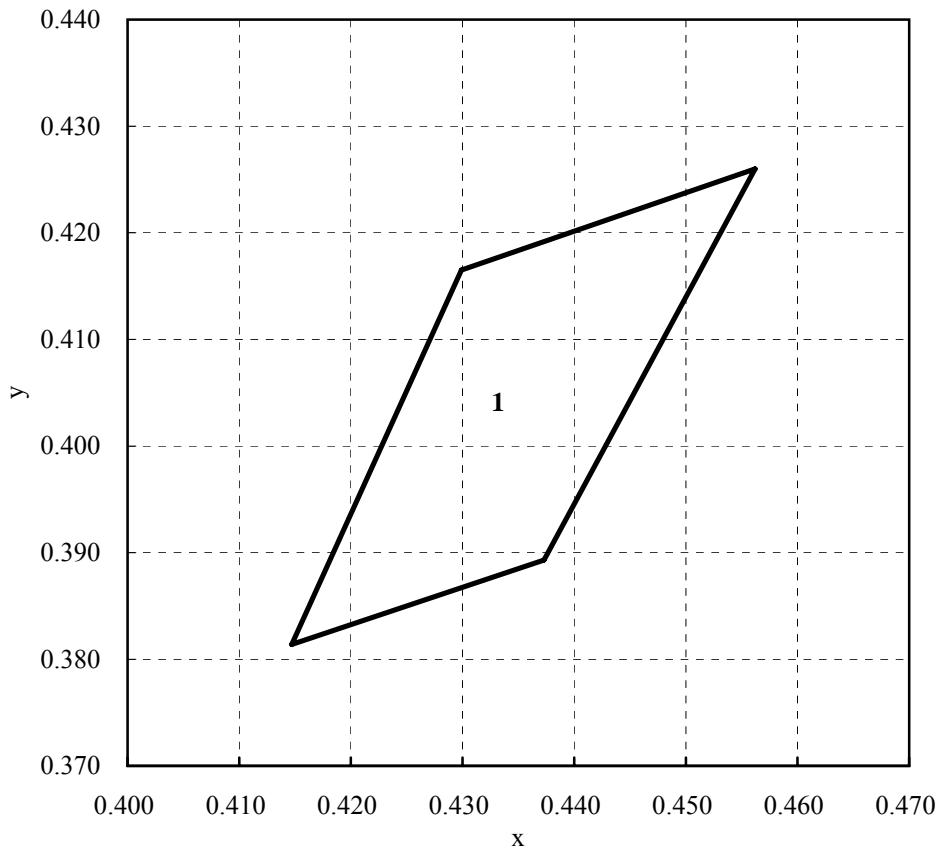

6-2. Packing

- One tray composed of 40 pieces
- 5 trays and one upper lid-tray in one moisture-proof bag
- 400 pieces (2 bags) in one carton
- Dimensions of outer carton: 235 × 220 × 90 mm (Reference value)

(Note 1) There are cases of one carton composed of one bag. (200 pieces)

(Note 2) State of packing is subject to change.

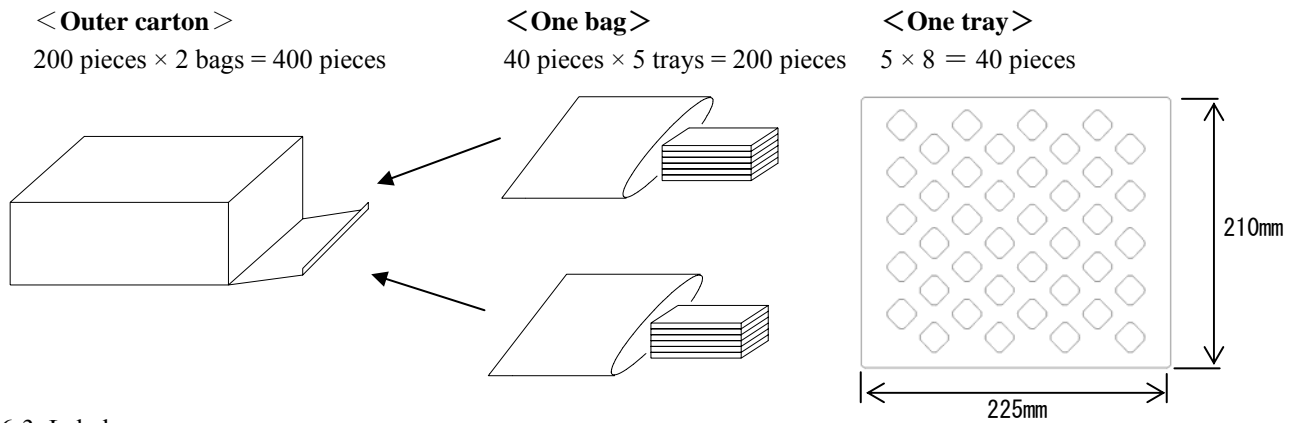

6-3. Label

Following label is attached on the moisture-proof bags.

SHIPMENT TABLE	
PART No. GW5BTC15L02 (GW5BTC15L02M)	← Model number
QUANTITY. 200 RANK 1	← Quantity and rank
LOT No. 5086G16054A	← Lot No.
	← EIAJ C-3 Bar code
SHARP CORPORATION MADE IN PHILIPPINES	← Production country
	← EIAJ C-3 Bar code
SHARP LABEL	

- ← Model number
- ← Quantity and rank
- ← Lot No.
- ← EIAJ C-3 Bar code
- ← Production country
- ← EIAJ C-3 Bar code

1) Lot No. indication

5 0 8 6 G 1 6 0 5 4 A

① ② ③ ④ ⑤ ⑥ ⑦

- ① Production plant code
- ② Shipping year (Year last digit)
- ③ Shipping month (1~9 or O, N, D)
- ④ Fixed code G
- ⑤ Shipping date (01~31)
- ⑥ Serial No.
- ⑦ Fixed code A

6-4. Indication printed on product

Model No. and control No. are indicated on substrate surface.

1) Model No.

Abbreviated Model No. "5BTC15L02" is indicated.

2) Control No.

Indicated as follows;

M 0 8 F 1 4 - 1

① ② ③ ④ ⑤

- ① Production plant code (to be indicated alphabetically)
- ② Year of production (the last two figures of the year)
- ③ Month of production
(to be indicated alphabetically with January corresponding to A)
- ④ Date of production (01~31)
- ⑤ Rank: Chromaticity rank is indicated as follows;
Rank 1 → 1

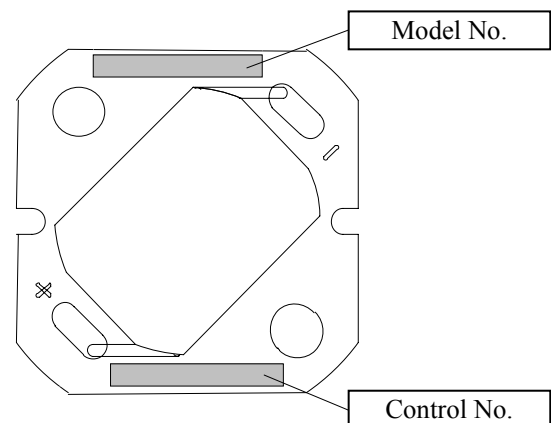

7. Precautions

① Storage conditions

Please follow the conditions below.

- Before opened: Temperature 5 ~ 30 °C, Relative humidity less than 60 %
- After opened: Temperature 5 ~ 30 °C, Relative humidity less than 60 % (Please apply soldering within 1 week.)
- Avoid exposing to air with corrosive gas.
If exposed, electrode surface would be damaged, which may affect soldering.

② Usage conditions

The products are not designed for the use under any of the following conditions.

Please confirm their performance and reliability well enough if you use under any of the following conditions;

- In a place with a lot of moisture, dew condensation, briny air, and corrosive gas.
(Cl, H₂S, NH₃, SO₂, NO_x, etc.)
- Under the direct sunlight, outdoor exposure, and in a dusty place.
- In water, oil, medical fluid, and organic solvent.

③ Heat radiation

If the forward current (I_F) is applied to single-state module at 360 mA, there is a risk of damaging module or emitting smoke.

Equip with specified heat radiator, and avoid heat stuffed inside the module.

Applying thermal conductive sheet or grease between module and heat radiator enables heat to radiate effectively.

④ Installation

Material of board is alumina ceramic. If installed inappropriately, trouble of no radiation may occur due to board crack. Please take particular notice of install method.

Further information on installation, refer to the following cautions.

- Apply ether screws or adhesives, or both of them when installed to heat radiator.
In case of applying adhesive only, check the effectiveness before fixing.
In case of screw, apply thread locker in order to prevent loosening.
If LED comes off from the heat radiator, unusual temperature rise entails hazardous phenomena including device deterioration, coming off of solder at leads, and emitting smoke.
- Refer to recommended dimensions when installing with screws.

- Screw torque: Within 0.2 Nm

If it is inefficient to tighten screws, apply locker to prevent loosening.

- It is recommended to apply screws which use low corrosive materials such as Stainless steel.

Avoid applying flat-head screws, which cause board crack due to applying stress to screw holes.

- Avoid convexly uneven boards.

Those convex boards are subject to crack when tightening screws.

- It is recommended to apply thermal conductive sheet or grease with adhesiveness and heat radiating-adhesives, because of thermal and mechanical combination between module and heat radiator.

However, depending on their thickness, board crack may be entailed by warped board, which is

caused when tightening screws. So please check your actual conditions carefully as for the screw torque.

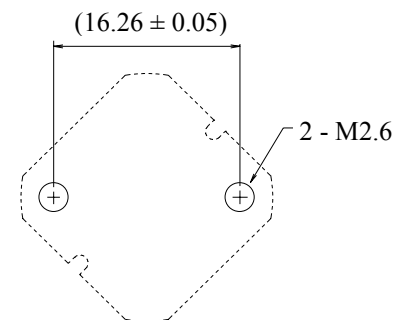

⑤ Module surface strength

Module surface is subject to mechanical stress. Applying stress to surface of modules results in damage on resin, and internal failure.

⑥ Connecting method

- In case of solder connecting method, follow the conditions mentioned below to prevent from alloy formation by terminal gold melted into solder.
Soldering iron with thermo controller (tip temperature 380 °C), within 10 seconds per one place.
- Secure the solderwettability on whole solder pad and leads.
- In soldering, put the ceramic board on materials whose conductivity is poor enough not to radiate heat of soldering.
- Avoid touching yellow phosphor with soldering iron.
- This product is not designed for reflow and flow soldering.
- Avoid such lead arrangement as applying stress to solder-applied area.

⑦ Static electricity

This product is subject to static electricity, so take measures to cope with it.
Install circuit protection device to drive circuit, if necessary.

⑧ Drive method

- Any reverse voltage cannot be applied to LEDs when they are in operation or not.
Design a circuit so that any flow of reverse or forward voltage can not be applied to LEDs when they are out of operation.
- There is a possibility of generating reverse voltage if ambient light is irradiated through LEDs off operation.
This derives from reverse current caused by electromotive force generated by ambient light.
Built in electromotive force-protection diodes or protect by insulating power supply with switch or transistor.
- Module is composed of LEDs connected in both series and parallel.
Constant voltage power supply runs off more than specified current amount due to lowered V_F caused by temperature rise.
Constant current power supply is recommended to drive.

⑨ Cleaning

Avoid cleaning, since silicone resin is eroded by cleaning.

⑩ Color-tone variation

Chromaticity of this product is monitored by integrating sphere right after the operation.
Chromaticity varies depending on measuring method, light spread condition, or ambient temperature.
Please verify your actual conditions before use.

⑪ Safety

- Looking directly at LEDs for a long time may result in hurt your eyes.
- In case that excess current (over ratings) are supplied to the device, hazardous phenomena including abnormal heat generation, emitting smoke, or catching fire can be caused.
Take appropriate measures to excess current and voltage.
- In case of solder connecting method, there is a possibility of fatigue failure by heat.
Please fix the leads in such case to protect from short circuit or leakage of electricity caused by contact.
- Please confirm the safety standards or regulations of application devices.

⑫ Other cautions

Guarantee covers the compliance to the quality standards mentioned in the Specifications, however it does not cover the compatibility with application of the end-use, including assembly and usage environment.

In case any quality problems occurred in the application of end-use, details will be separately discussed and determined between the parties hereto.